

# Russian 23rd Mechanized Corps

June 22, 1941

27th  
Motorcycle  
Regiment

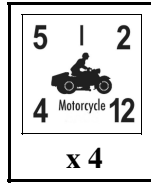

82nd  
Engineer  
Battalion

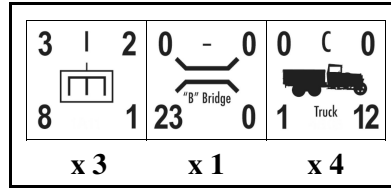

95th & 96th  
Tank  
Regiments

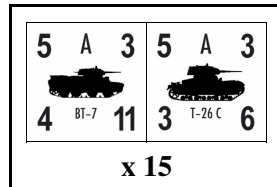

About 150 light tanks listed for this division. They would be some mix of these two types, but mostly T-26.

48th  
Motorized  
Infantry  
Regiment

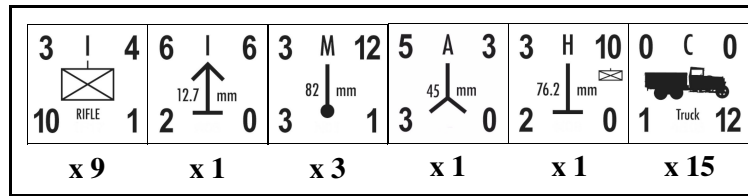

48th  
Tank  
Division

48th  
Howitzer  
Regiment

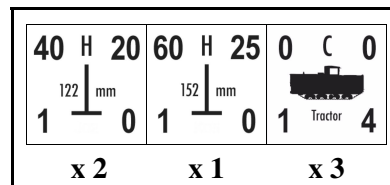

48th  
Engineer  
Battalion

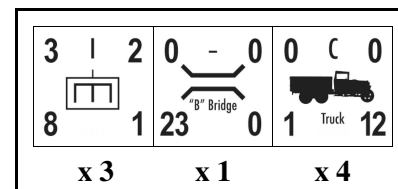

48th Anti-  
Aircraft  
Battalion

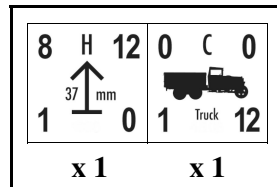

48th  
Recon  
Battalion

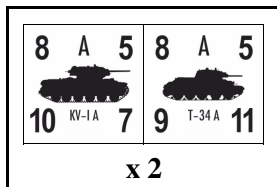
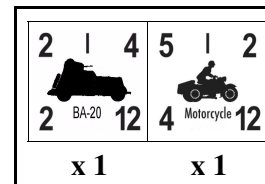



This mech corps has 20 KV-I and T-34 tanks but I don't know the exact composition or placement of them. They should be part of the 48th or 51st Tank Divisions.

# Russian 23rd Mechanized Corps

June 22, 1941







51st  
Tank  
Division

101st & 102nd  
Tank  
Regiments



5	A	3	5	A	3
					
4	BT-7	11	3	T-26 C	6
x 14					

About 140 light tanks listed for this division. They would be some mix of these two types, but mostly T-26.



51st  
Motorized  
Infantry  
Regiment

3	I	4	6	I	6	3	M	12	5	A	3	3	H	10	0	C	0
																	
10	RIFLE	1	2	0	3	1	3	0	2	0	1	Truck	12				
x 9		x 1		x 3		x 1		x 1		x 15							



51st  
Howitzer  
Regiment

40	H	20	60	H	25	0	C	0	
									
1		0	1		0	1	Tractor	4	
x 2		x 1		x 3					



51st  
Engineer  
Battalion

3	I	2	0	-	0	0	C	0	
									
8		1	23	0	1	Truck	12		
x 3		x 1		x 4					

51st Anti-  
Aircraft  
Battalion

8	H	12	0	C	0
					
1		0	1	Truck	12
x 1		x 1			

51st  
Recon  
Battalion

2	I	4	5	I	2
					
2	BA-20	12	4	Motorcycle	12
x 1		x 1			

# Russian 23rd Mechanized Corps

June 22, 1941

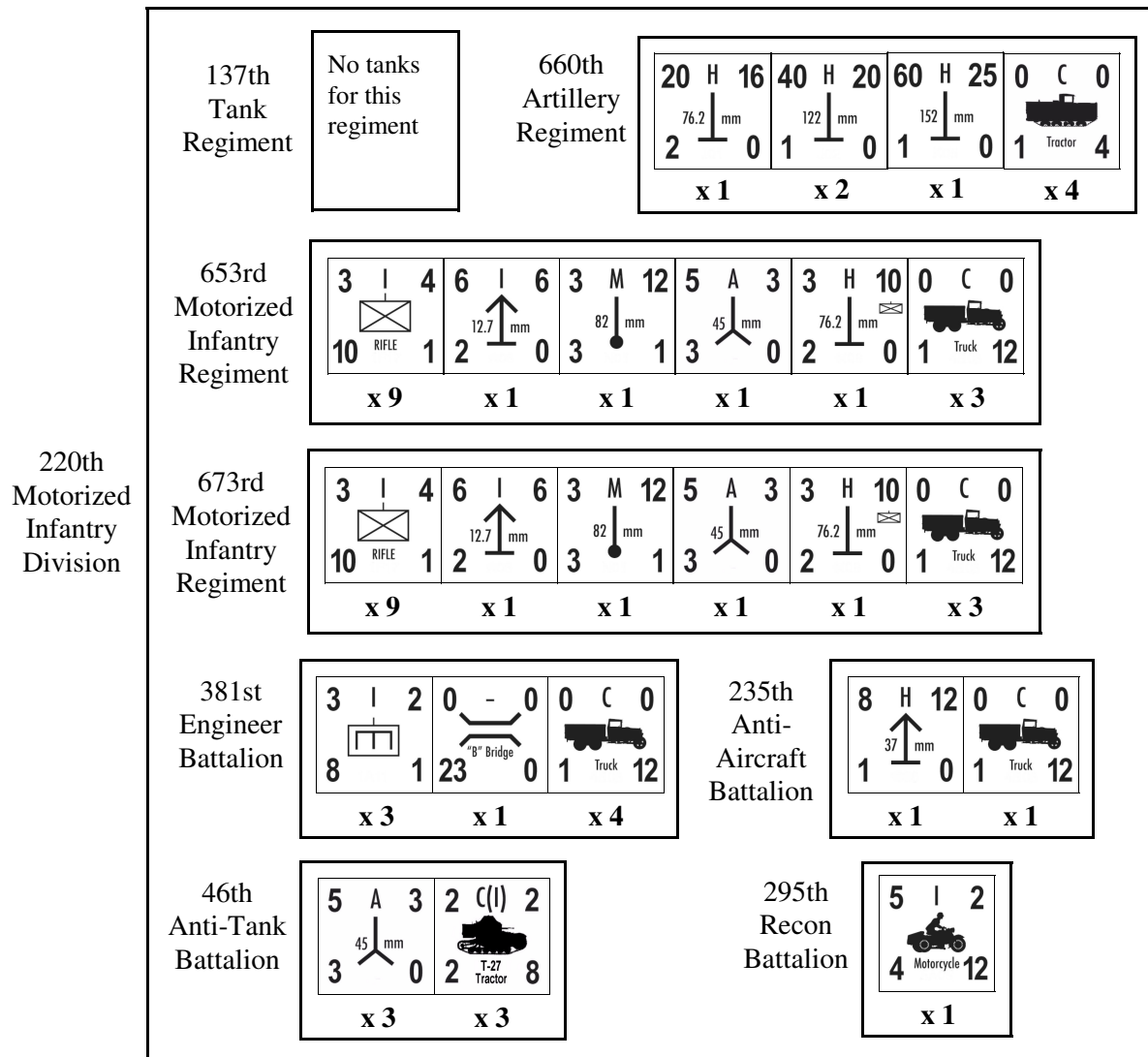

On June 22, 1941, the 23rd Mech Corps was stationed in the interior at Odessa. In early July the corps was ordered to the front and engaged the Germans on the 9th of July. The corps was largely destroyed after a couple of weeks.