

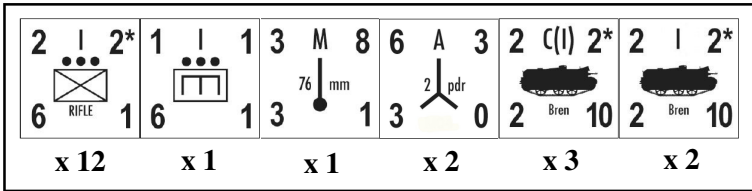
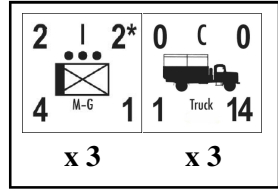
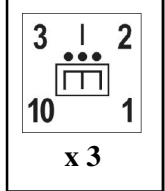
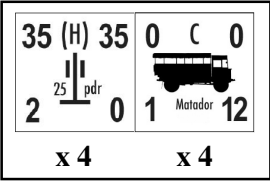
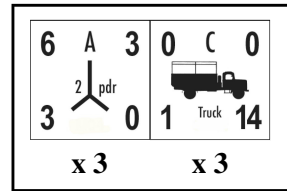
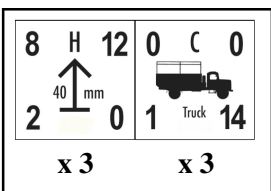

British 50th Infantry Division

May 26, 1942

69th
Infantry
Brigade

<p>Infantry Battalion x 3</p> 	<p>5th Battalion, East Yorkshire Rgt.</p> <p>6th Battalion, Green Howards</p> <p>7th Battalion, Green Howards</p>	
<p>A, 2nd Cheshire Machine Gun Battalion</p> 	<p>233rd Field Co. Royal Engineers</p> 	<p>124th Field Regiment Artillery</p> 
<p>257th Anti-Tank Battery</p> 	<p>Battery, 15th Light AA Regiment</p> 	

150th
Infantry
Brigade

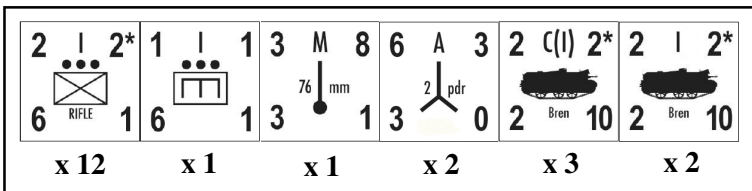
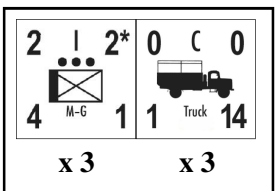
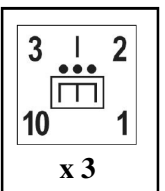
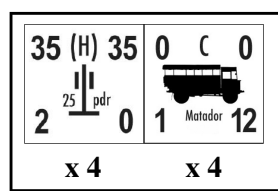
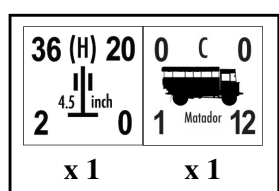
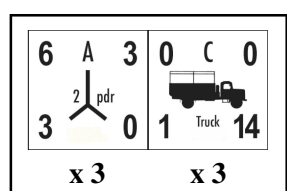
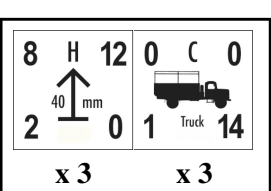
<p>Infantry Battalion x 3</p> 	<p>4th Battalion East Yorkshire Rgt.</p> <p>4th Battalion Green Howards</p> <p>5th Battalion Green Howards</p>	
<p>D, 2nd Cheshire Machine Gun Battalion</p> 	<p>232nd Field Co. Royal Engineers</p> 	
<p>72nd Field Regiment Artillery</p> 	<p>7th Medium Regiment Artillery (-)</p> 	
<p>259th Anti-Tank Battery</p> 	<p>Battery, 15th Light AA Regiment</p> 	

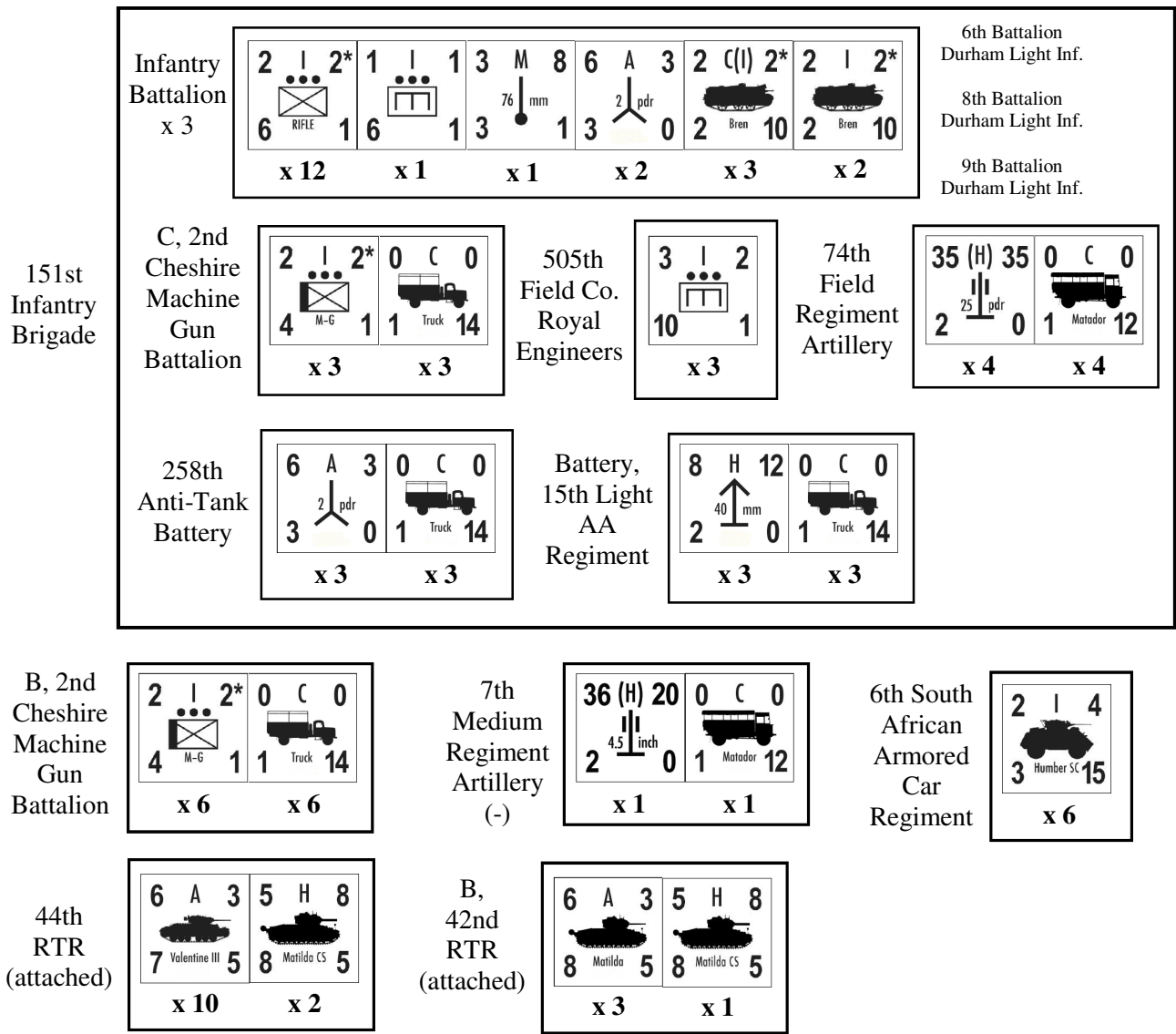

The 50th Division was deployed in three fortified brigade boxes with the northern two close to the South Africans and the third one, manned by the 150th Brigade, set 5 to 10 miles further south. The northern two boxes were not heavily engaged in the battle but the 150th Brigade box soon found itself heavily involved. As the battle developed, the Axis pushed two supply paths through the minefields, one to the north of the 150th and one to the south. The 150th was able to harass these two supply lanes so effectively that the Axis forces were compelled to attack the brigade box. Elements of the 15th Panzer, Trieste, and 90th Light Divisions, along with Stuka air support pounded the box. After a very tough stand, the survivors of the isolated 150th Brigade were finally forced to surrender at noon on June 1st.