







Sollum-Halfaya Pass Gruppe

Stuetzpunkt (strongpoint) Halfaya

I/104th
Infantry
Battalion
(-)

2 I 2	4 I 4	3 I 2	3 M 12	8 A 5	5 A 2	2 H 12	0 C 0
 RIFLE	 HMG		81 mm	50 mm	37 mm	75 mm	 Truck
8 1	4 1	10 1	3 1	3 0	3 0	2 0	1 12
x 6	x 2	x 1	x 1	x 1	x 2	x 1	x 6



I/33rd
Flak
Regiment
(-)

4 H 10	0 C 0	15 A 20	0 C 0
20 mm	 Truck	88 mm	 SdKfz 8
1 0	1 12	1 0	1 10
x 2	x 2	x 1	x 1

I/2nd
Italian
Artillery
Regiment
(-)



40 (H) 32	0 C 0
100 mm	 TL 37
2 0	1 8
x 1	x 1

II/62nd
Italian
Infantry
Regiment
(-)

2 I 2	2 I 2*	2 H 12	6 A 3	0 C 0
 RIFLE	 M-G	65 mm	47 mm	 Truck
5 1	4 1	2 0	3 0	1 12
x 3	x 1	x 1	x 1	x 2





Most of these forces were on the high ground with the low ground very thinly defended but heavily mined.

Stuetzpunkt Qalala

German	Italian	Italian	Italian
2 I 2	1 I 2	40 (H) 32	0 C 0
 RIFLE	 RIFLE	100 mm	 TL 37
6 1	5 1	2 0	1 8
x 3	x 1	x 1	x 1





This strongpoint was located on the high ground about 3 miles east of Halfaya Pass and consisted of the German 6th Oasis Company plus some Italian artillery and a little bit of Italian infantry.

Stuetzpunkt Capuzzo

I/61st Italian Infantry Regiment (-)	2 I 2	6 A 3	4 H 10	0 C 0
 RIFLE	 47 mm	 20 mm	 Truck	
5 1	3 0	1 0	1 12	
x 3	x 1	x 1	x 2	





The Italians once again defended Fort Capuzzo with a reinforced infantry company.

Stuetzpunkt Musaid

II/62nd Italian Infantry Regiment (-)	2 I 2	6 A 3	3 M 12	0 C 0
 RIFLE	 47 mm	 81 mm	 Truck	
5 1	3 0	3 1	1 12	
x 3	x 1	x 1	x 3	





This strongpoint was halfway between Fort Capuzzo and Sollum and was defended by a reinforced infantry company.



Stuetzpunkt Ober Sollum

II/62nd Italian Infantry Regiment (-)	2	I	2	6	A	3	3	M	12	0	C	0
			1	3		0	3		1		12	
	x 3		x 1		x 1		x 2					

Strongpoint Upper Sollum was defended by another reinforced Italian Infantry company.



Stuetzpunkt 206



15th Motorcycle Battalion (1 reinforced company)	2	I	2	4	I	4	4	H	10	5	A	2	0	C	0
			1			1		0		0		12			
	x 3		x 1		x 1		x 1		x 3						



I/33rd Artillery Regiment (-)	40 (H)	32	0	C	0
		0		1	10
	x 1		x 1		

This strongpoint was located about 5 miles south of Fort Capuzzo.

Stuetzpunkt 208







4/15th Motorcycle Battalion	4	I	4	4	H	10	0	C	0
			1		0		12		
	x 2		x 1						



I/33rd Flak Regiment (-)	15	A	20	0	C	0
		0		1	10	
	x 1		x 1			



From 33rd Anti-Tank Battalion	5	A	2	0	C	0
		0		1	12	
	x 1		x 1			

This strongpoint was located about 5 miles west of Fort Capuzzo and was manned by German forces.

Mobile Infantry Reserve

15th Motorcycle Battalion (-)	2	I	2	3	I	2	3	M	12	5	A	2	2	H	12	0	C	0
			1			1		1		0		0		12				
	x 6		x 1		x 1		x 1		x 1		x 10							

I/33rd Artillery Regiment (-)	40 (H)	32	0	C	0
		0		1	10
	x 1		x 1		

I/33rd Flak Regiment (-)	4	H	10	0	C	0
		0		1	12	
	x 1		x 1			

This mobile reserve force was stationed somewhere behind the front ready to be deployed as needed.

The Panzer battalions were again held in reserve behind the front, ready to launch a counterstrike at any breakthroughs.

Panzer Striking Force

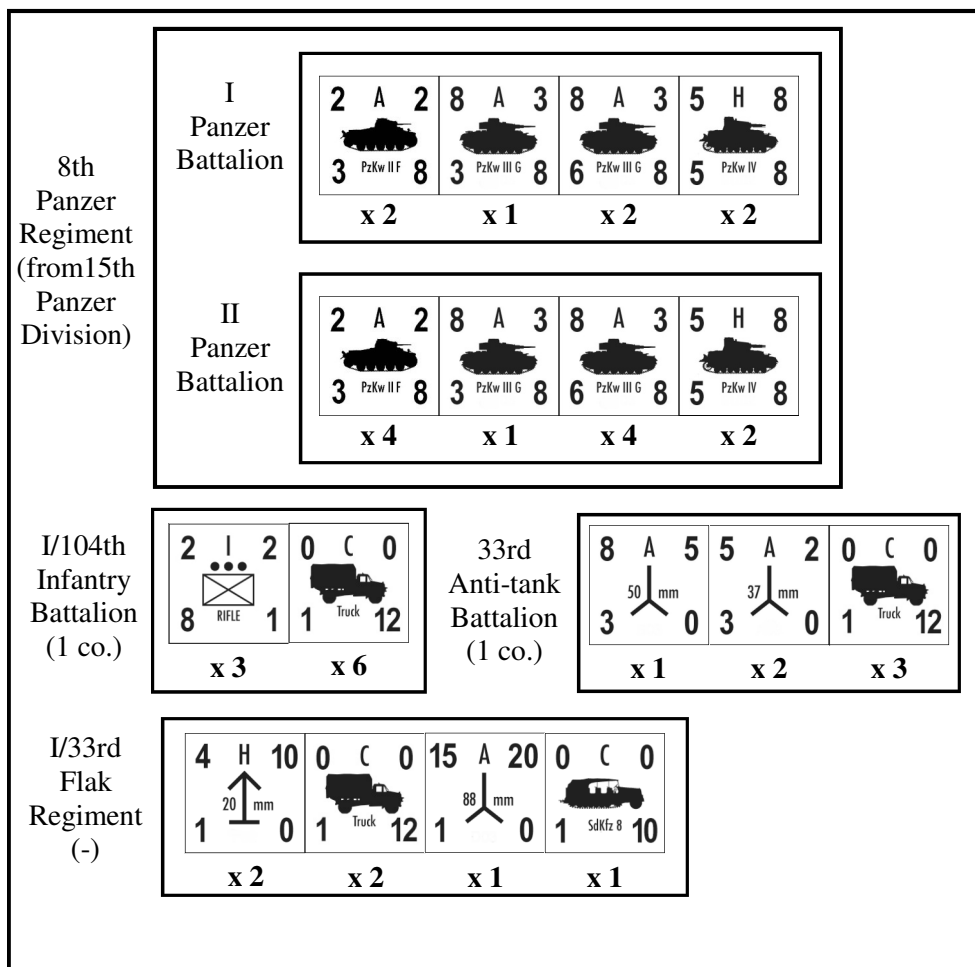

This group was held in reserve north of Fort Capuzzo. After the fort fell, it was ordered to retake the fort against dug-in Matildas and 25 pdr guns. The attack was defeated with many tank losses.

Panzer Regiment 5 (from 5th Light Division)

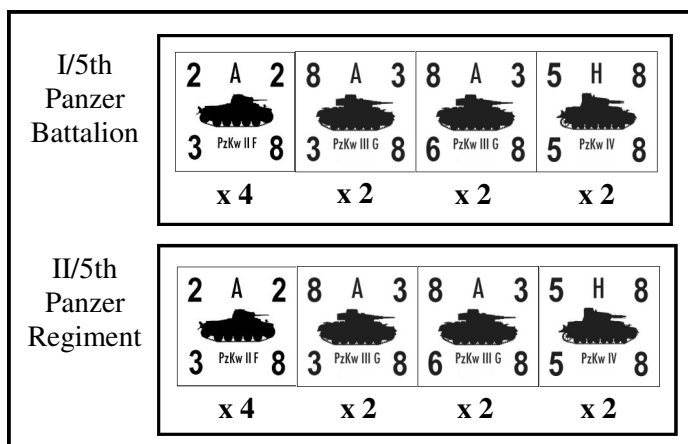

When Operation Battleaxe began, this regiment was back by Tobruk keeping an eye on things there. It was rushed to the front and helped defeat the Allied attack.